

STAMFORD®

UCI274D - Technical Data Sheet Winding 06

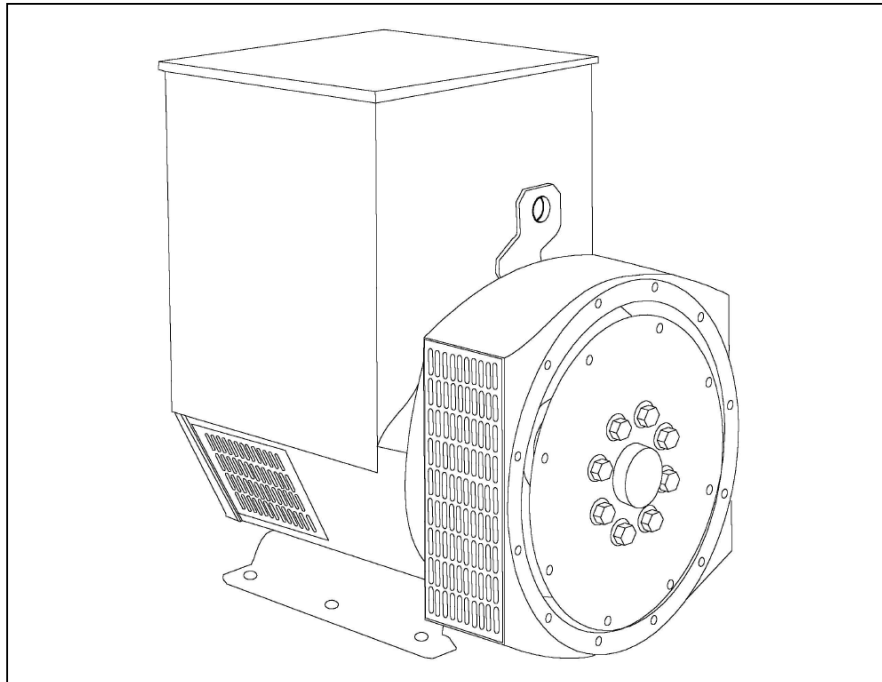

UCI274D

SPECIFICATIONS & OPTIONS

STAMFORD

STANDARDS

Newage Stamford industrial generators meet the requirements of BS EN 60034 and the relevant section of other international standards such as BS5000, VDE 0530, NEMA MG1-32, IEC34, CSA C22.2-100, AS1359. Other standards and certifications can be considered on request.

VOLTAGE REGULATORS

SX460 AVR - STANDARD

With this self excited control system the main stator supplies power via the Automatic Voltage Regulator (AVR) to the exciter stator. The high efficiency semiconductors of the AVR ensure positive build-up from initial low levels of residual voltage.

The exciter rotor output is fed to the main rotor through a three phase full wave bridge rectifier. This rectifier is protected by a surge suppressor against surges caused, for example, by short circuit.

AS440 AVR

With this self-excited system the main stator provides power via the AVR to the exciter stator. The high efficiency semiconductors of the AVR ensure positive build-up from initial low levels of residual voltage.

The exciter rotor output is fed to the main rotor through a three-phase full-wave bridge rectifier. The rectifier is protected by a surge suppressor against surges caused, for example, by short circuit or out-of-phase paralleling.

The AS440 will support a range of electronic accessories, including a 'droop' Current Transformer (CT) to permit parallel operation with other ac generators.

MX341 AVR

This sophisticated AVR is incorporated into the Stamford Permanent Magnet Generator (PMG) control system.

The PMG provides power via the AVR to the main exciter, giving a source of constant excitation power independent of generator output. The main exciter output is then fed to the main rotor, through a full wave bridge, protected by a surge suppressor. The AVR has in-built protection against sustained over-excitation, caused by internal or external faults. This de-excites the machine after a minimum of 5 seconds.

An engine relief load acceptance feature can enable full load to be applied to the generator in a single step.

MX321 AVR

The most sophisticated of all our AVRs combines all the features of the MX341 with, additionally over voltage protection built-in and short circuit current level adjustments as an optional facility.

WINDINGS & ELECTRICAL PERFORMANCE

All generator stators are wound to 2/3 pitch. This eliminates triplen (3rd, 9th, 15th ...) harmonics on the voltage waveform and is found to be the optimum design for trouble-free supply of non-linear loads. The 2/3 pitch design avoids excessive neutral currents sometimes seen with higher winding pitches, when in parallel with the mains. A fully connected damper winding reduces oscillations during paralleling. This winding, with the 2/3 pitch and carefully selected pole and tooth designs, ensures very low waveform distortion.

TERMINALS & TERMINAL BOX

Dedicated Single Phase windings have 4 ends brought out to the terminals, which are mounted on a cover at the non-drive end of the generator. A sheet steel terminal box contains the AVR and provides ample space for the customers' wiring and gland arrangements. It has removable panels for easy access.

SHAFT & KEYS

All generator rotors are dynamically balanced to better than BS6861:Part 1 Grade 2.5 for minimum vibration in operation. Two bearing generators are balanced with a half key.

INSULATION/IMPREGNATION

The insulation system is class 'H'.

All wound components are impregnated with materials and processes designed specifically to provide the high build required for static windings and the high mechanical strength required for rotating components.

QUALITY ASSURANCE

Generators are manufactured using production procedures having a quality assurance level to BS EN ISO 9001.

The stated voltage regulation may not be maintained in the presence of certain radio transmitted signals. Any change in performance will fall within the limits of Criteria 'B' of EN 61000-6-2:2001. At no time will the steady-state voltage regulation exceed 2%.

NB Continuous development of our products entitles us to change specification details without notice, therefore they must not be regarded as binding.

Front cover drawing typical of product range.

UCI274D

STAMFORD

WINDING 06

CONTROL SYSTEM	SEPARATELY EXCITED BY P.M.G.		
A.V.R.	MX341	MX321	
VOLTAGE REGULATION	± 1%	± 0.5 %	With 4% ENGINE GOVERNING
SUSTAINED SHORT CIRCUIT	REFER TO SHORT CIRCUIT DECREMENT CURVES (page 6)		
CONTROL SYSTEM	SELF EXCITED		
A.V.R.	SX460	AS440	
VOLTAGE REGULATION	± 1.5 %	± 1.0 %	With 4% ENGINE GOVERNING
SUSTAINED SHORT CIRCUIT	SERIES 4 CONTROL DOES NOT SUSTAIN A SHORT CIRCUIT CURRENT		
INSULATION SYSTEM	CLASS H		
PROTECTION	IP23		
RATED POWER FACTOR	0.8		
STATOR WINDING	SINGLE LAYER CONCENTRIC		
WINDING PITCH	TWO THIRDS		
WINDING LEADS	4		
MAIN STATOR RESISTANCE	0.0137 Ohms AT 22°C SERIES CONNECTED		
MAIN ROTOR RESISTANCE	1.26 Ohms at 22°C		
EXCITER STATOR RESISTANCE	20 Ohms at 22°C		
EXCITER ROTOR RESISTANCE	0.091 Ohms PER PHASE AT 22°C		
R.F.I. SUPPRESSION	BS EN 61000-6-2 & BS EN 61000-6-4, VDE 0875G, VDE 0875N. refer to factory for others		
WAVEFORM DISTORTION	NO LOAD < 1.5% NON-DISTORTING LINEAR LOAD < 5.0%		
MAXIMUM OVERSPEED	2250 Rev/Min		
BEARING DRIVE END	BALL. 6315-2RS (ISO)		
BEARING NON-DRIVE END	BALL. 6310-2RS (ISO)		
	1 BEARING	2 BEARING	
WEIGHT COMP. GENERATOR	431 kg	450 kg	
WEIGHT WOUND STATOR	141 kg	141 kg	
WEIGHT WOUND ROTOR	149.37 kg	138.41 kg	
WR ² INERTIA	1.1962 kgm ²	1.1455 kgm ²	
SHIPPING WEIGHTS in a crate	458 kg	476 kg	
PACKING CRATE SIZE	105 x 67 x 103(cm)	105 x 67 x 103(cm)	
TELEPHONE INTERFERENCE	THF<2%	TIF<50	
COOLING AIR	0.617 m ³ /sec 1308 cfm		
VOLTAGE SERIES	220	230	240
VOLTAGE PARALLEL	110	115	120
kVA BASE RATING FOR REACTANCE VALUES	96	96	96
X _d DIR. AXIS SYNCHRONOUS	2.48	2.26	2.08
X' _d DIR. AXIS TRANSIENT	0.20	0.19	0.17
X'' _d DIR. AXIS SUBTRANSIENT	0.14	0.13	0.12
X _q QUAD. AXIS REACTANCE	1.46	1.34	1.23
X' _q QUAD. AXIS SUBTRANSIENT	0.20	0.19	0.17
X _L LEAKAGE REACTANCE	0.07	0.07	0.06
X ₂ NEGATIVE SEQUENCE	0.17	0.15	0.14
X ₀ ZERO SEQUENCE	0.10	0.09	0.08
REACTANCES ARE SATURATED	VALUES ARE PER UNIT AT RATING AND VOLTAGE INDICATED		
T' _d TRANSIENT TIME CONST.	0.031s		
T'' _d SUB-TRANSTIME CONST.	0.01s		
T' _{do} O.C. FIELD TIME CONST.	0.85s		
T _a ARMATURE TIME CONST.	0.0073s		
SHORT CIRCUIT RATIO	1/X _d		

UCI274D

STAMFORD

Winding 06

SINGLE PHASE EFFICIENCY CURVES

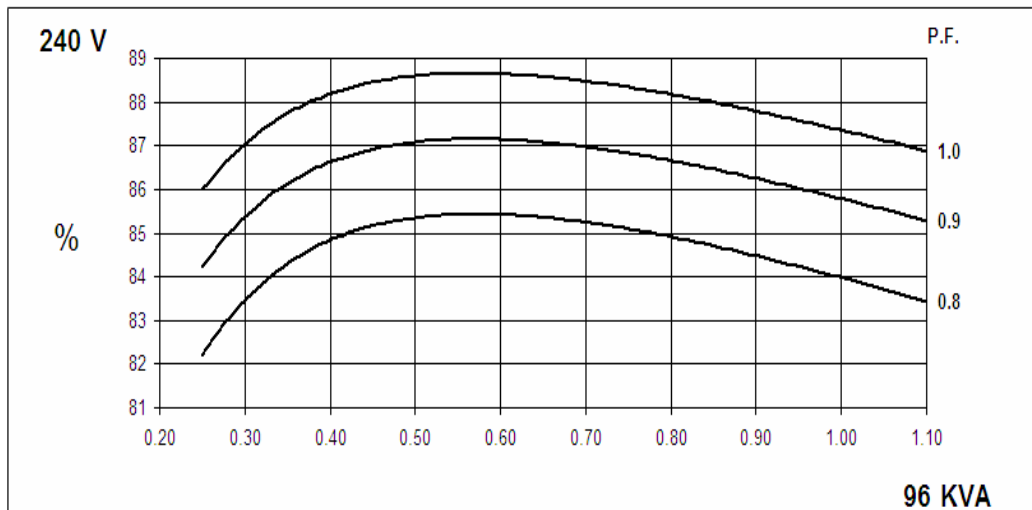
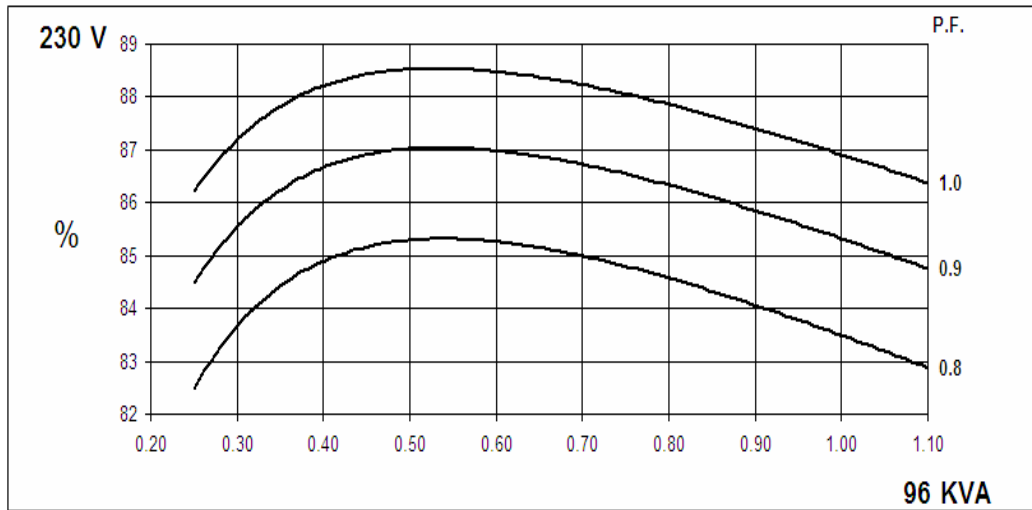
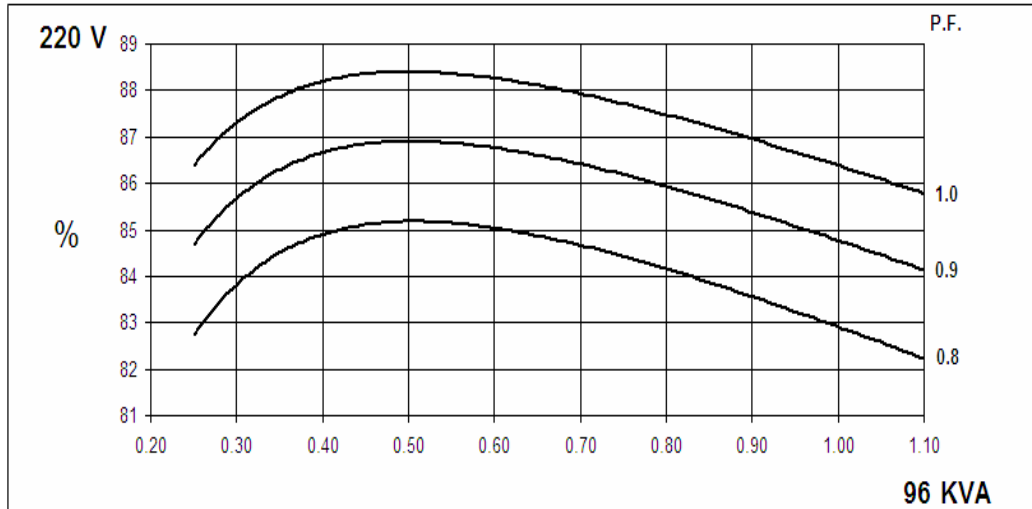

UCI274D

STAMFORD

Winding 06

SX

Locked Rotor Motor Starting Curves

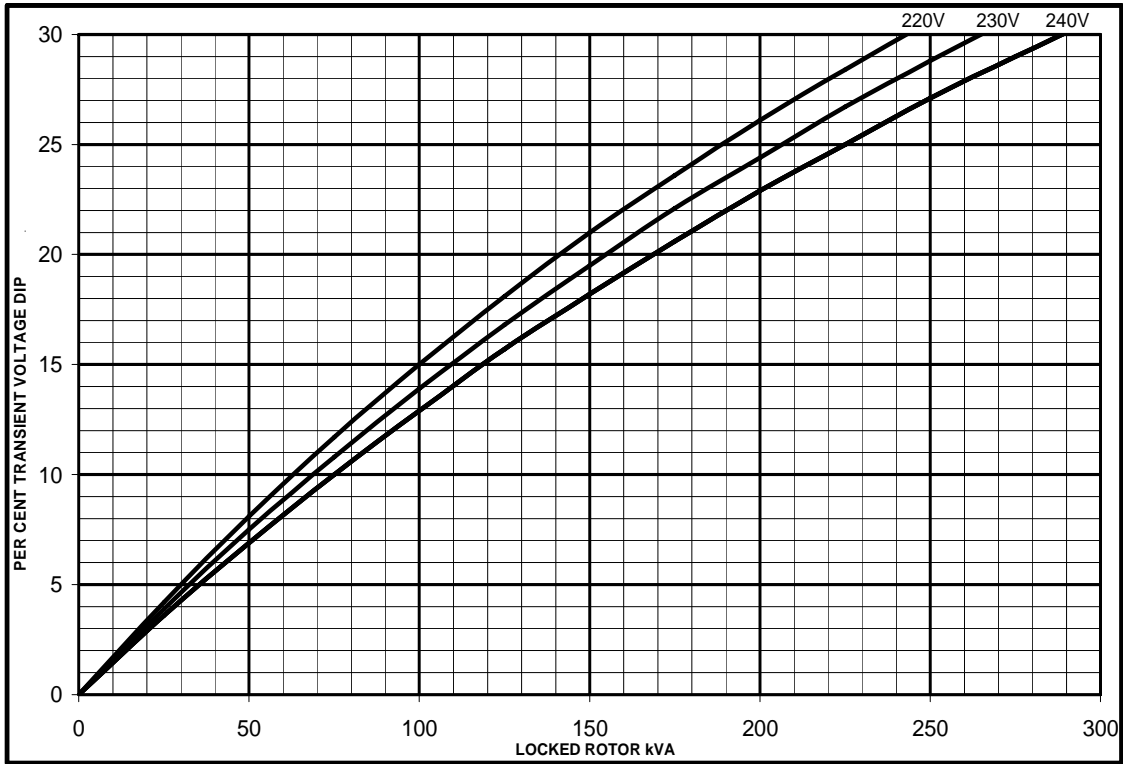

MX

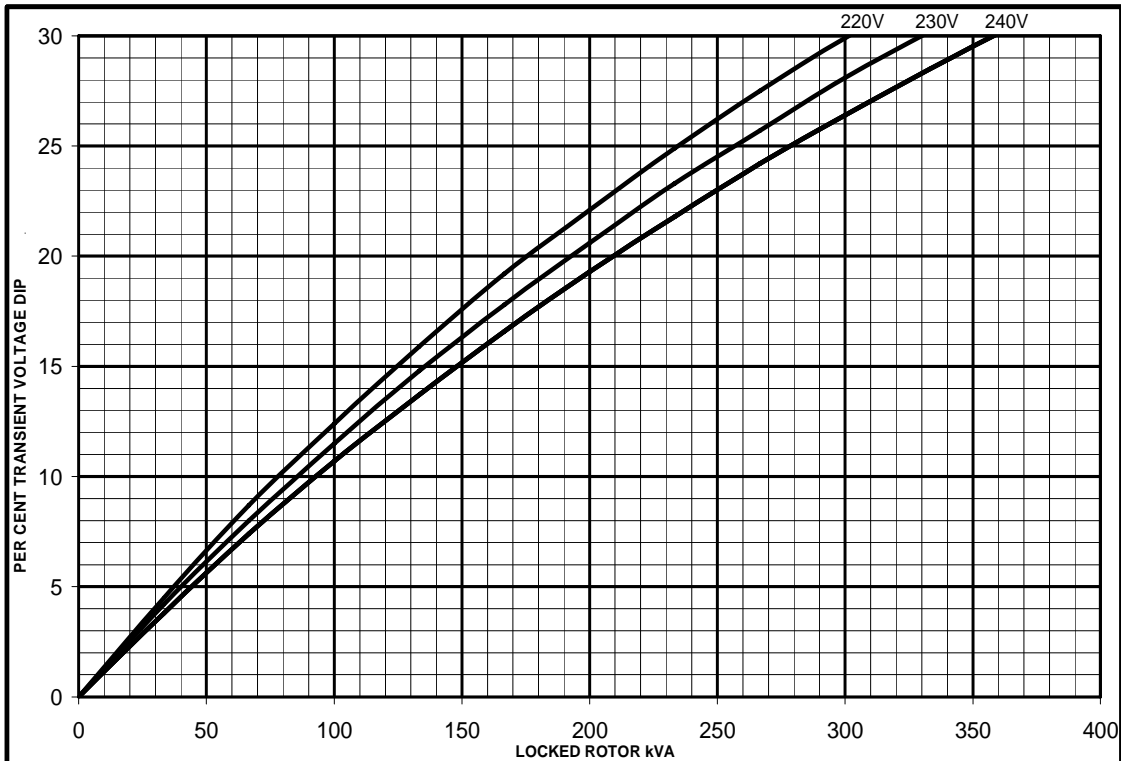

UCI274D
Winding 06

STAMFORD

**Short Circuit Decrement Curve. No-load Excitation at Rated Speed
Based on series connection.**

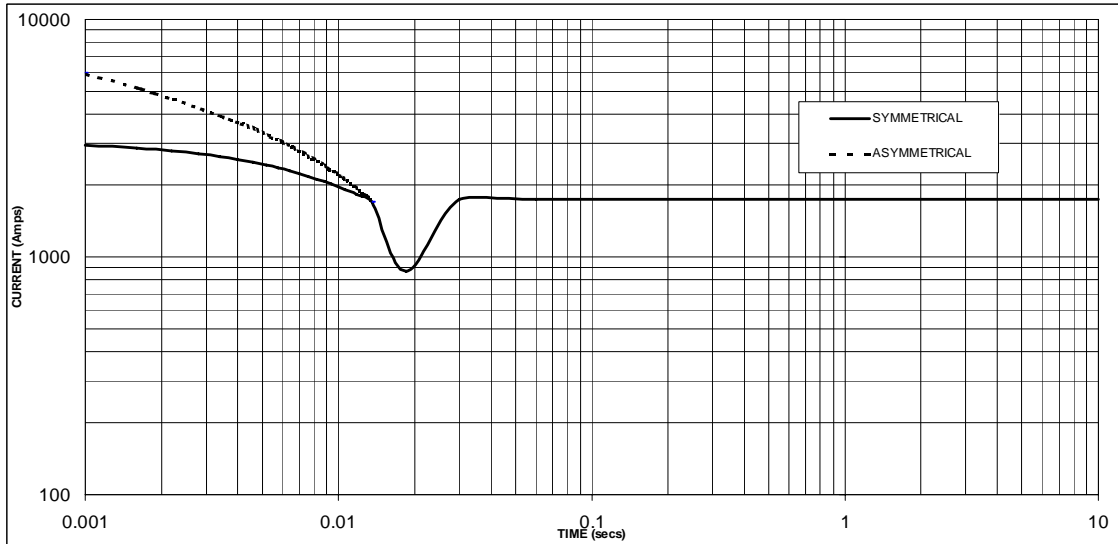

Sustained Short Circuit = 1750 Amps

Note

The following multiplication factors should be used to adjust the values from curve between time 0.001 seconds and the minimum current point in respect of nominal operating voltage :

Voltage	Factor
220V	X 1.00
230V	X 1.05
240V	X 1.09

The sustained current value is constant irrespective of voltage level

UCI274D

STAMFORD

Winding 06 / 0.8 Power Factor

60Hz

RATINGS

Class - Temp Rise	Cont. F - 105/40°C			Cont. H - 125/40°C			Standby - 150/40°C			Standby - 163/27°C		
Series (V)	220	230	240	220	230	240	220	230	240	220	230	240
Parallel (V)	110	115	120	110	115	120	110	115	120	110	115	120
kVA	87.5	87.5	87.5	96.0	96.0	96.0	N/A			N/A		
kW	70.0	70.0	70.0	76.8	76.8	76.8						
Efficiency (%)	83.5	84.0	84.4	82.9	83.5	84.0						
kW Input	83.8	83.3	82.9	92.6	92.0	91.4						

DIMENSIONS

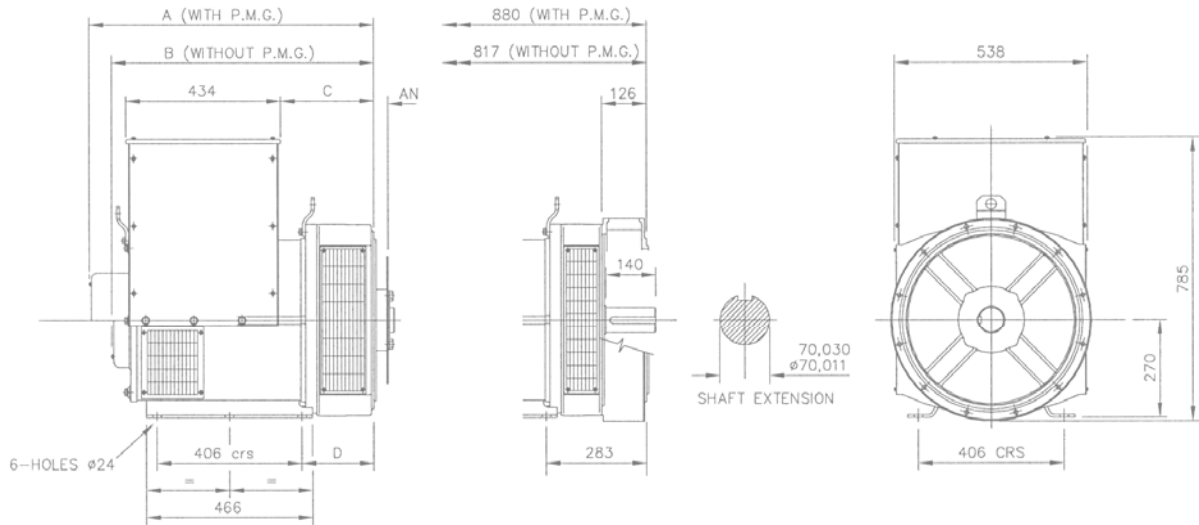

SINGLE BEARING ADAPTORS				
ADAPTOR	A	B	C	D
SAE 1	813,3	750,3	274,3	216,3
SAE 2	799	736	260	202
SAE 3	799	736	260	202

COUPLING DISCS	
DISC	AN
SAE 10	53,98
SAE 11,5	39,68
SAE 14	25,40

STAMFORD

Barnack Road • Stamford • Lincolnshire • PE9 2NB
 Tel: 00 44 (0)1780 484000 • Fax: 00 44 (0)1780 484100